

HM31/710

Nutmuttern



Details:

Hauptabmessungen

Gewicht [kg]	≈ 180	B [mm]	106
G [mm]	Tr710x7	b [mm]	55
d ₁ [mm]	825	h [mm]	30
d ₂ [mm]	900		

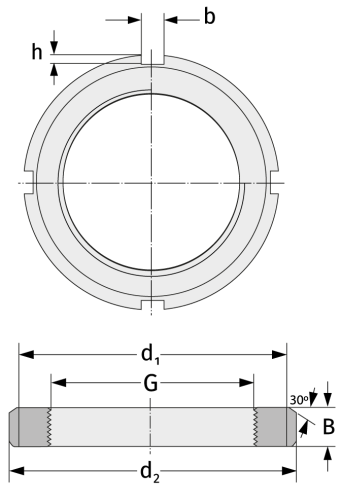

Anschlussmaße

Enthaltene Komponenten

Sicherung

MS31/710