

HM3144

Nutmuttern



Details:

Hauptabmessungen

Gewicht [kg]	≈ 5,16	B [mm]	32
G [mm]	Tr220x4	b [mm]	20
d ₁ [mm]	250	h [mm]	10
d ₂ [mm]	280		

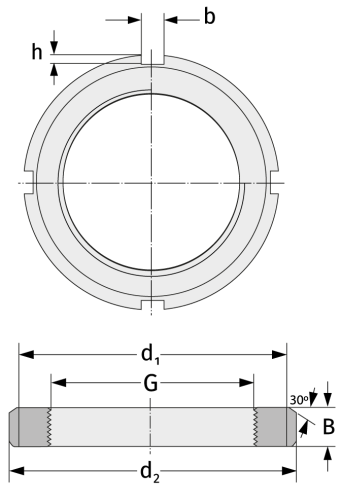

Anschlussmaße	Enthaltene Komponenten	
	Sicherung	MB44