

HM3160

Nutmuttern



Details:

Hauptabmessungen			
Gewicht [kg]	≈ 11,7	B [mm]	40
		b [mm]	24
G [mm]	Tr300x 4	h [mm]	12
d ₁ [mm]		340	
d ₂ [mm]	380		

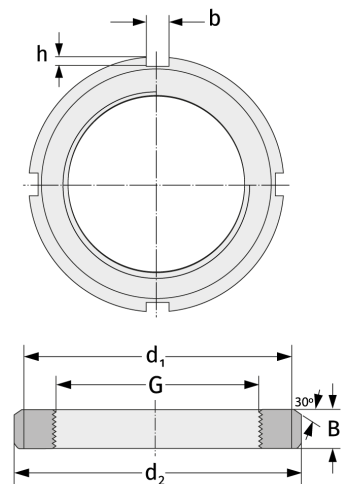

Anschlussmaße	Enthaltene Komponenten	
	Sicherung	MS3160