

HM3180

Nutmuttern



Details:

Hauptabmessungen			
Gewicht [kg]	≈ 36,7	B [mm]	62
		b [mm]	32
G [mm]	Tr400X 5	h [mm]	18
d ₁ [mm]		460	
d ₂ [mm]	520		

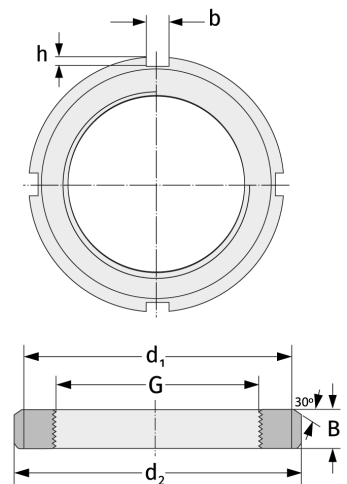

Anschlussmaße	Enthaltene Komponenten	
	Sicherung	MS3180