

HM3184

Nutmuttern



Details:

Hauptabmessungen

Gewicht [kg]	≈ 43,3	B [mm]	70
G [mm]	Tr420x5	b [mm]	32
d ₁ [mm]	490	h [mm]	18
d ₂ [mm]	540		

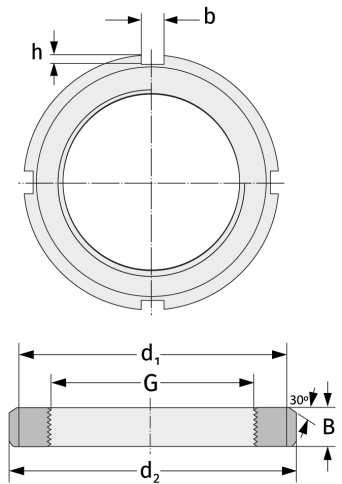

Anschlussmaße

Enthaltene Komponenten

Sicherung

MS3180