

# HM3188

Nutmuttern



## Details:

Hauptabmessungen			
Gewicht [kg]	≈ 45,1	B [mm]	70
		b [mm]	36
G [mm]	Tr440x 5	h [mm]	20
d <sub>1</sub> [mm]		510	
d <sub>2</sub> [mm]	560		

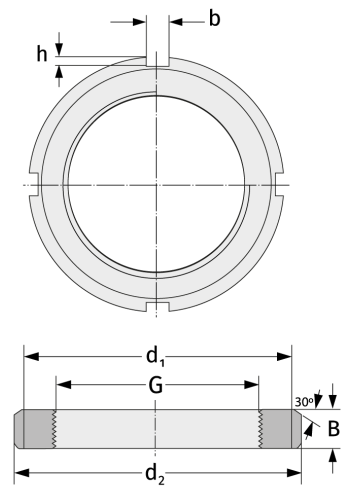

Anschlussmaße	Enthaltene Komponenten	
	Sicherung	MS3188