

HM3192

Nutmuttern



Details:

Hauptabmessungen			
Gewicht [kg]	≈ 50,2	B [mm]	75
		b [mm]	36
G [mm]	Tr460x 5	h [mm]	20
d ₁ [mm]		540	
d ₂ [mm]	580		

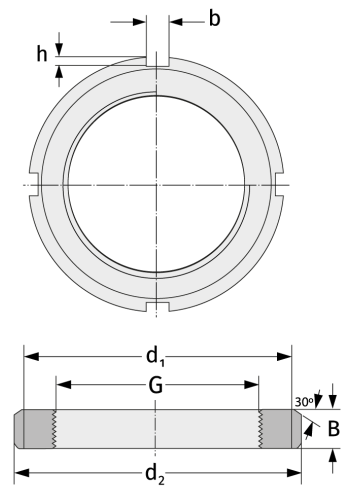

Anschlussmaße	Enthaltene Komponenten	
	Sicherung	MS3188