

KM15

Nutmuttern



Details:

Hauptabmessungen			
Gewicht [kg]	≈ 0,287	B [mm]	13
G [mm]	M75x2	b [mm]	8
d ₁ [mm]	90	h [mm]	3,5
d ₂ [mm]	98		

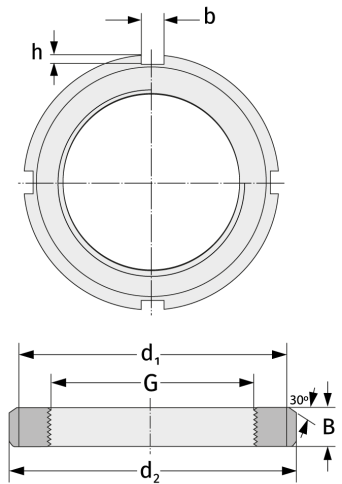

Anschlussmaße

Enthaltene Komponenten

Sicherung

MB15