

KM26

Nutmuttern



Details:

Hauptabmessungen			
Gewicht [kg]	≈ 1,25	B [mm]	21
G [mm]	M130x2	b [mm]	12
d ₁ [mm]	149	h [mm]	5
d ₂ [mm]	165		

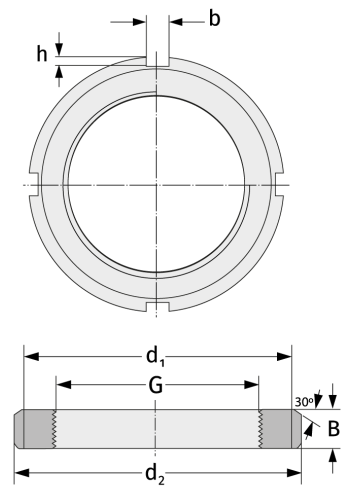

Anschlussmaße	Enthaltene Komponenten	
	Sicherung	MB26