

KM36

Nutmuttern



Details:

Hauptabmessungen			
Gewicht [kg]	≈ 3,07	B [mm]	27
		b [mm]	18
G [mm]	M180x3	h [mm]	8
d ₁ [mm]	203		
d ₂ [mm]	230		

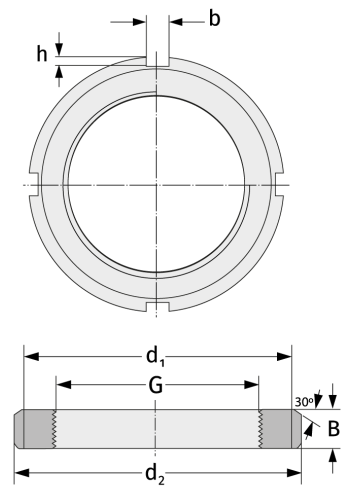

Anschlussmaße	Enthaltene Komponenten	
	Sicherung	MB36