

KM38

Nutmuttern



Details:

Hauptabmessungen

Gewicht [kg]	≈ 3,39	B [mm]	28
G [mm]	M190x3	b [mm]	18
d ₁ [mm]	214	h [mm]	8
d ₂ [mm]	240		

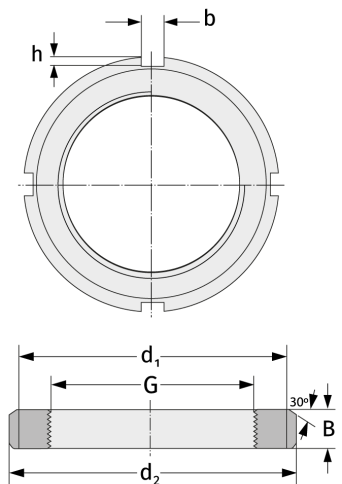

Anschlussmaße	Enthaltene Komponenten	
	Sicherung	MB38