

KM8

Nutmuttern



Details:

Hauptabmessungen			
Gewicht [kg]	≈ 0,085	B [mm]	9
		b [mm]	6
G [mm]	M40x1, 5	h [mm]	2,5
d ₁ [mm]	50		
d ₂ [mm]	58		

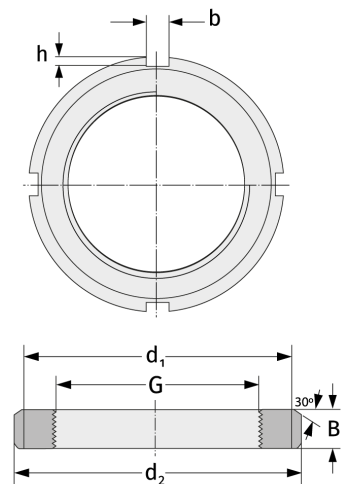

Anschlussmaße	Enthaltene Komponenten	
	Sicherung	MB8