

KML38

Nutmuttern



Details:

Hauptabmessungen			
Gewicht [kg]	≈ 2,08	B [mm]	28
G [mm]	M190x3	b [mm]	16
d ₁ [mm]	210	h [mm]	5
d ₂ [mm]	220		

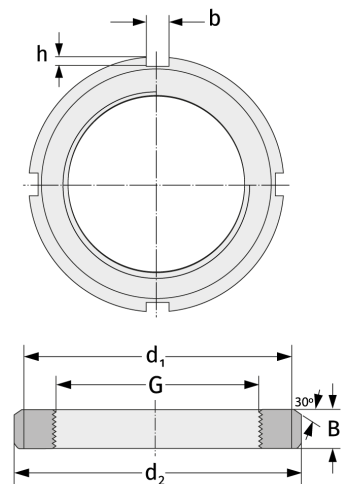

Anschlussmaße	Enthaltene Komponenten	
	Sicherung	MBL28