

MB1

Sicherungsbleche



Details:

Hauptabmessungen

Gewicht [kg]	≈ 0,19	s [mm]	1
		b ₁ [mm]	3
d ₁ [mm]	12	b ₂ [mm]	3
d ₂ [mm]	25	M [mm]	10,5
d ₃ [mm]	17		

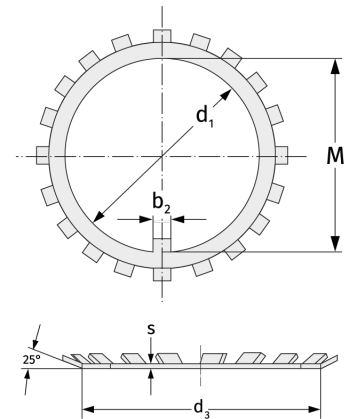

Anschlussmaße

Berechnungsdaten