

MB17

Sicherungsbleche



Details:

Hauptabmessungen

Gewicht [kg]	≈ 5,3	s [mm]	1,75
d_1 [mm]	85	b_1 [mm]	8
d_2 [mm]	119	b_2 [mm]	10
d_3 [mm]	102	M [mm]	81,5

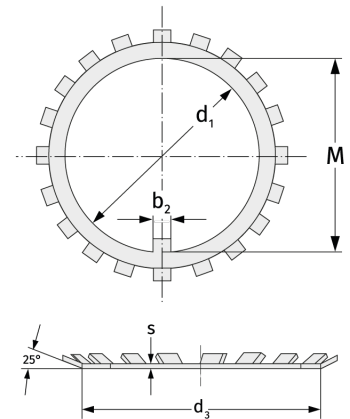

Anschlussmaße

Berechnungsdaten