

MB19

Sicherungsbleche



Details:

Hauptabmessungen

Gewicht [kg]	≈ 6,7	s [mm]	1,75
d_1 [mm]	95	b_1 [mm]	10
d_2 [mm]	133	b_2 [mm]	10
d_3 [mm]	113	M [mm]	91,5

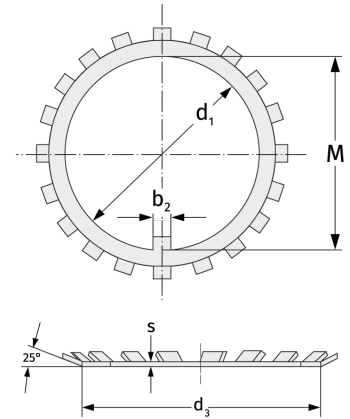

Anschlussmaße

Berechnungsdaten