

MB2

Sicherungsbleche



Details:

Hauptabmessungen

Gewicht [kg]	≈ 0,25	s [mm]	1
		b ₁ [mm]	4
d ₁ [mm]	15	b ₂ [mm]	4
d ₂ [mm]	28	M [mm]	13,5
d ₃ [mm]	21		

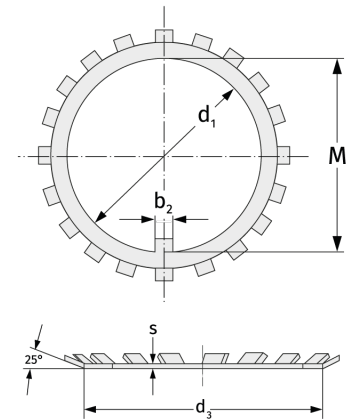

Anschlussmaße

Berechnungsdaten