

MB20

Sicherungsbleche



Details:

Hauptabmessungen

Gewicht [kg]	≈ 7,7	s [mm]	1,75
d_1 [mm]	100	b_1 [mm]	10
d_2 [mm]	142	b_2 [mm]	12
d_3 [mm]	120	M [mm]	96,5

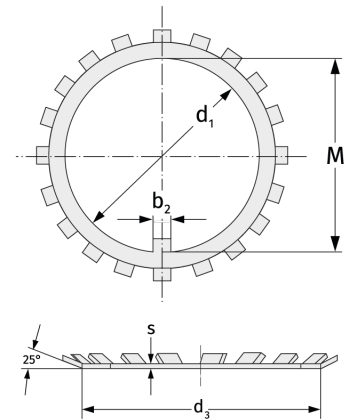

Anschlussmaße

Berechnungsdaten