

MB28

Sicherungsbleche



Details:

Hauptabmessungen

Gewicht [kg]	≈ 14,2	s [mm]	2
		b ₁ [mm]	14
d ₁ [mm]	140	b ₂ [mm]	16
d ₂ [mm]	192	M [mm]	135
d ₃ [mm]	160		

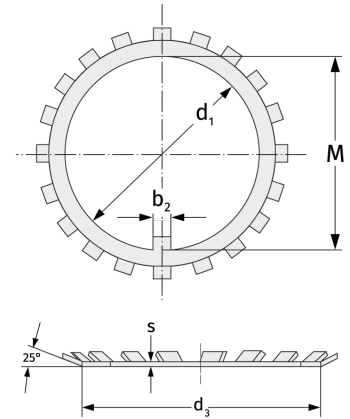

Anschlussmaße

Berechnungsdaten