

MB29

Sicherungsbleche



Details:

Hauptabmessungen

Gewicht [kg]	≈ 16,8	s [mm]	2
		b ₁ [mm]	14
d ₁ [mm]	145	b ₂ [mm]	16
d ₂ [mm]	202	M [mm]	140
d ₃ [mm]	171		

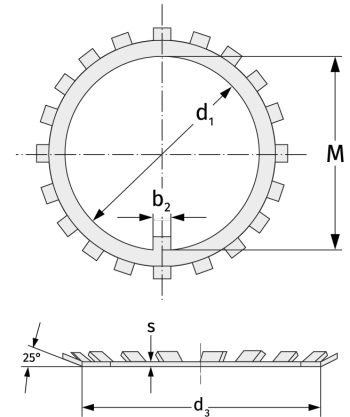

Anschlussmaße

Berechnungsdaten