

MB30

Sicherungsbleche



Details:

Hauptabmessungen

Gewicht [kg]	≈ 15,5	s [mm]	2
		b ₁ [mm]	14
d ₁ [mm]	150	b ₂ [mm]	16
d ₂ [mm]	205	M [mm]	145
d ₃ [mm]	171		

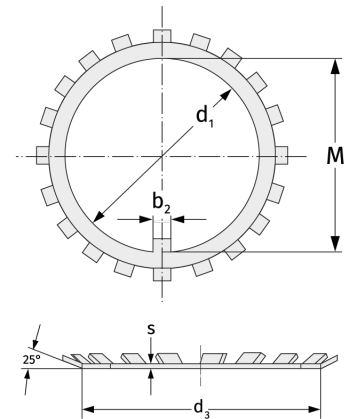

Anschlussmaße

Berechnungsdaten