

MB4

Sicherungsbleche



Details:

Hauptabmessungen			
Gewicht [kg]	≈ 0,35	s [mm]	1
		b ₁ [mm]	4
d ₁ [mm]	20	b ₂ [mm]	4
d ₂ [mm]	36	M [mm]	18,5
d ₃ [mm]	25		

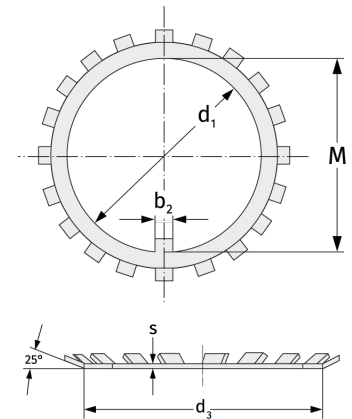

Anschlussmaße

Berechnungsdaten