

# MBL24

Sicherungsbleche



## Details:

### Hauptabmessungen

Gewicht [kg]	≈ 7,7	s [mm]	2
		b <sub>1</sub> [mm]	12
d <sub>1</sub> [mm]	120	b <sub>2</sub> [mm]	14
d <sub>2</sub> [mm]	148	M [mm]	115
d <sub>3</sub> [mm]	135		

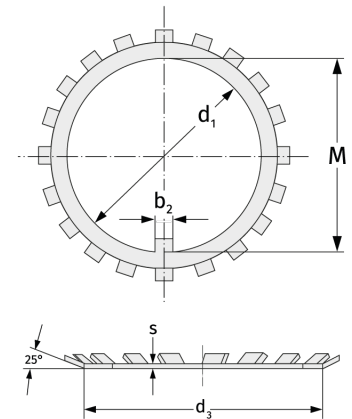

### Anschlussmaße

### Berechnungsdaten