

# MBL36

Sicherungsbleche



## Details:

### Hauptabmessungen

Gewicht [kg]	≈ 18	s [mm]	2,5
$d_1$ [mm]	180	$b_1$ [mm]	16
$d_2$ [mm]	215	$b_2$ [mm]	20
$d_3$ [mm]	200	M [mm]	174

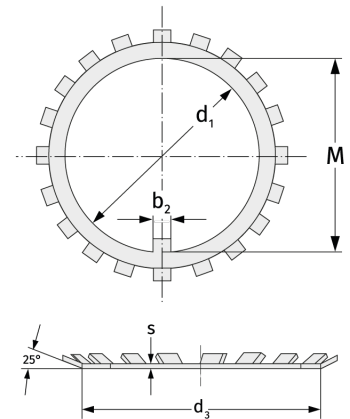

### Anschlussmaße

### Berechnungsdaten