

MS30/710

Sicherungsbügel



Details:

Hauptabmessungen

Gewicht [kg]	≈ 0,279	e [mm]	39
b ₁ [mm]	50	d ₅ [mm]	18
h ₁ [mm]	21	b ₃ [mm]	52
s [mm]	7	t [mm]	15

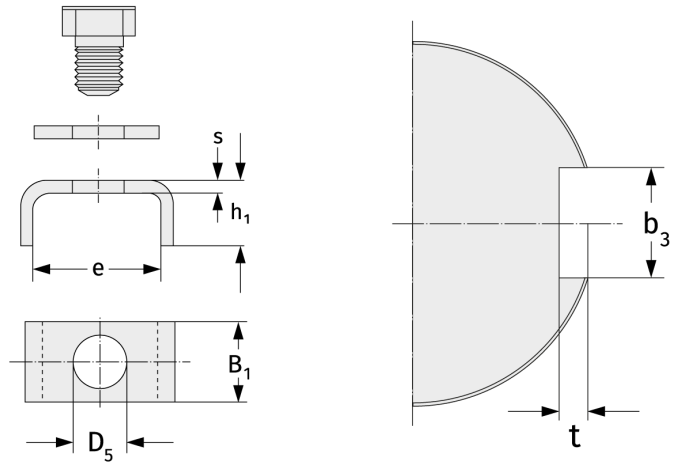

Anschlussmaße

Berechnungsdaten