

# MS30/850

Sicherungsbügel



## Details:

### Hauptabmessungen

Gewicht [kg]	≈ 0,426	e [mm]	44
b <sub>1</sub> [mm]	60	d <sub>5</sub> [mm]	22
h <sub>1</sub> [mm]	21	b <sub>3</sub> [mm]	62
s [mm]	7	t [mm]	15

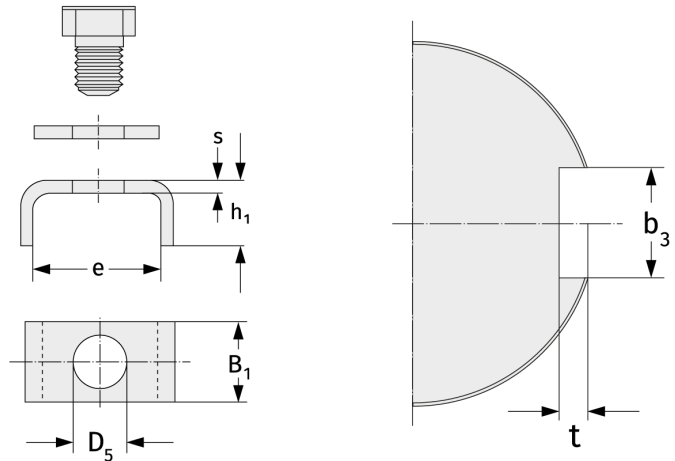

### Anschlussmaße

### Berechnungsdaten