

# MS31/530

Sicherungsbügel



## Details:

### Hauptabmessungen

Gewicht [kg]	≈ 0,347	e [mm]	51
b <sub>1</sub> [mm]	40	d <sub>5</sub> [mm]	22
h <sub>1</sub> [mm]	21	b <sub>3</sub> [mm]	42
s [mm]	7	t [mm]	14

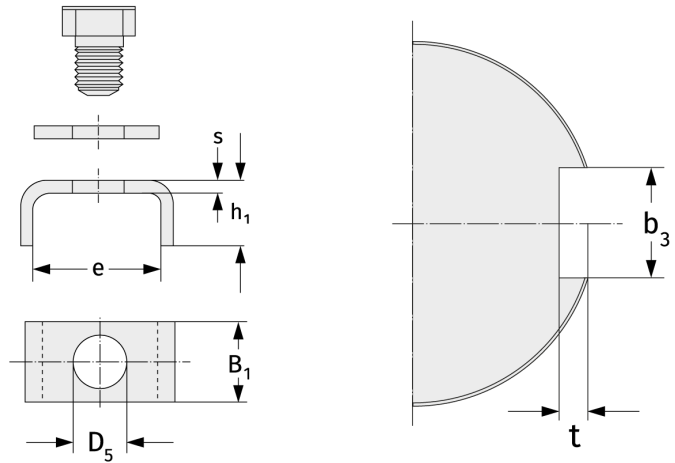

### Anschlussmaße

### Berechnungsdaten