

MS31/710

Sicherungsbügel



Details:

Hauptabmessungen

Gewicht [kg]	≈ 0,58	e [mm]	69
b ₁ [mm]	55	d ₅ [mm]	26
h ₁ [mm]	21	b ₃ [mm]	57
s [mm]	7	t [mm]	15

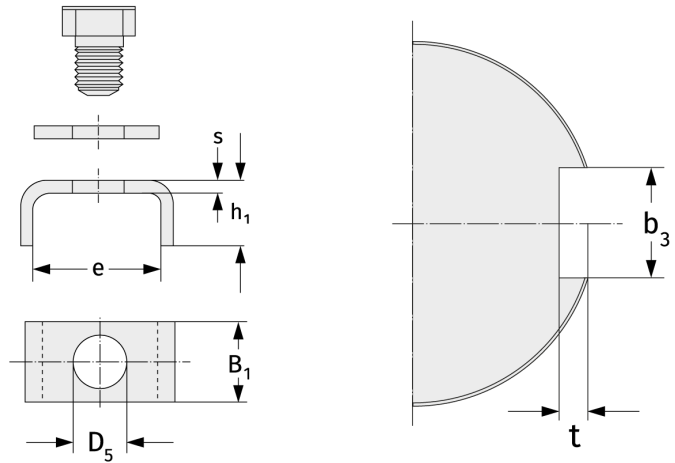

Anschlussmaße

Berechnungsdaten