

MS31/750

Sicherungsbügel



Details:

Hauptabmessungen

Gewicht [kg]	≈ 0,614	e [mm]	70
b ₁ [mm]	60	d ₅ [mm]	26
h ₁ [mm]	21	b ₃ [mm]	62
s [mm]	7	t [mm]	15

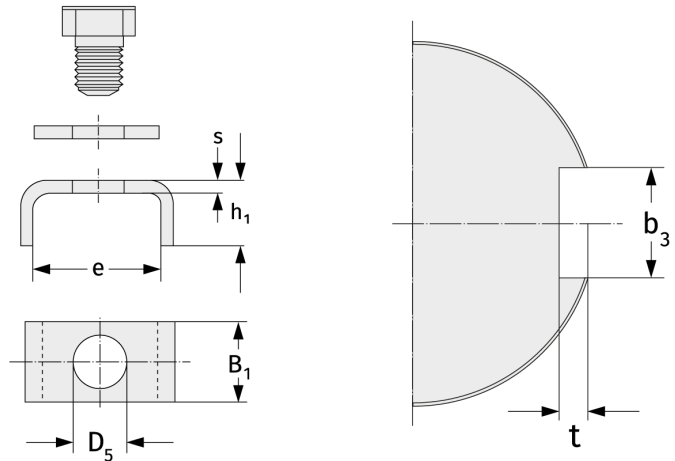

Anschlussmaße

Berechnungsdaten