

MS31/850

Sicherungsbügel



Details:

Hauptabmessungen

Gewicht [kg]	≈ 0,679	e [mm]	71
b ₁ [mm]	70	d ₅ [mm]	26
h ₁ [mm]	21	b ₃ [mm]	72
s [mm]	7	t [mm]	16

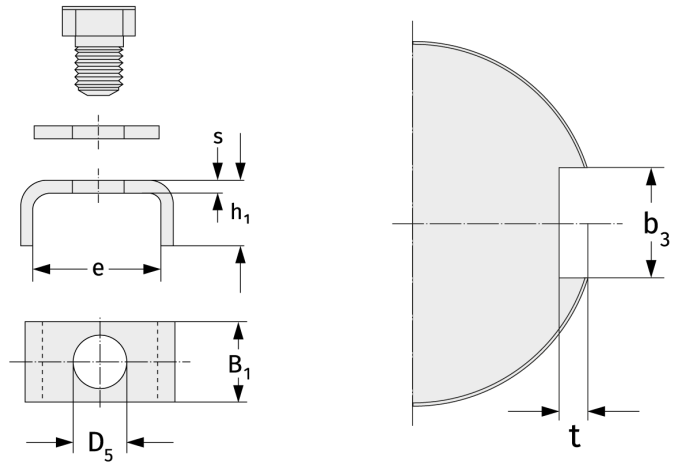

Anschlussmaße

Berechnungsdaten