

MS31/900

Sicherungsbügel



Details:

Hauptabmessungen

Gewicht [kg]	≈ 0,698	e [mm]	76
b ₁ [mm]	70	d ₅ [mm]	26
h ₁ [mm]	21	b ₃ [mm]	72
s [mm]	7	t [mm]	16

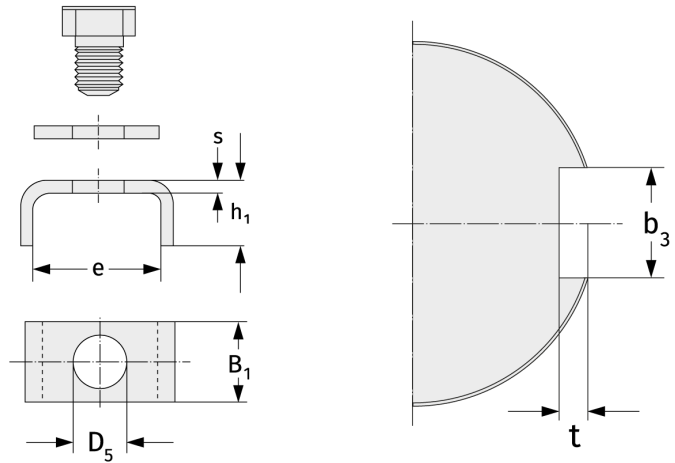

Anschlussmaße

Berechnungsdaten