

MS31/950

Sicherungsbügel



Details:

Hauptabmessungen

Gewicht	≈ 0,706	e [mm]	78
[kg]		d ₅ [mm]	26
b ₁ [mm]	70	b ₃ [mm]	72
h ₁ [mm]	21	t [mm]	16
s [mm]	7		

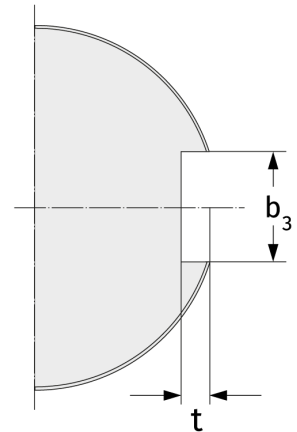
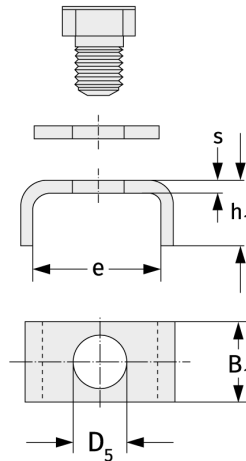

Anschlussmaße

Berechnungsdaten