

MS3144

Sicherungsbügel



Details:

Hauptabmessungen

Gewicht [kg]	≈ 0,038	e [mm]	22,5
b ₁ [mm]	20	d ₅ [mm]	9
h ₁ [mm]	12	b ₃ [mm]	22
s [mm]	4	t [mm]	9

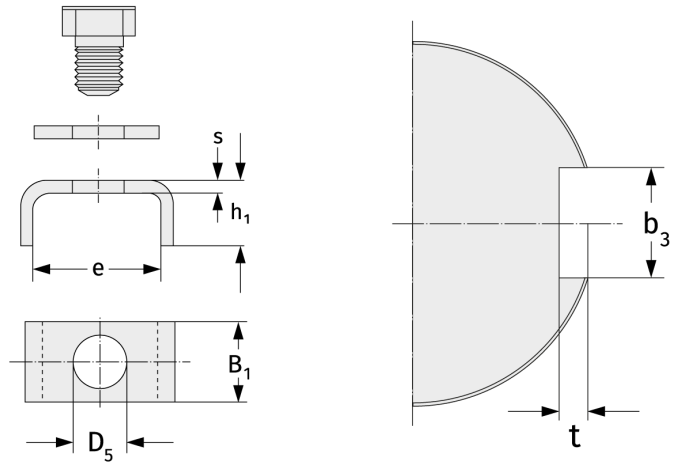

Anschlussmaße

Berechnungsdaten