

MS3152

Sicherungsbügel



Details:

Hauptabmessungen

Gewicht [kg]	≈ 0,056	e [mm]	25,5
b ₁ [mm]	24	d ₅ [mm]	11
h ₁ [mm]	12	b ₃ [mm]	26
s [mm]	4	t [mm]	9

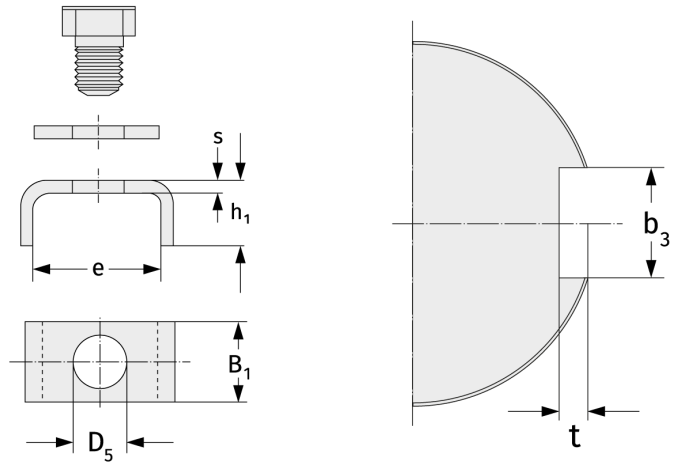

Anschlussmaße

Berechnungsdaten