

MS3176

Sicherungsbügel



Details:

Hauptabmessungen

Gewicht [kg]	≈ 0,115	e [mm]	40
		d_5 [mm]	14
b_1 [mm]	32	b_3 [mm]	34
h_1 [mm]	15	t [mm]	10
s [mm]	5		

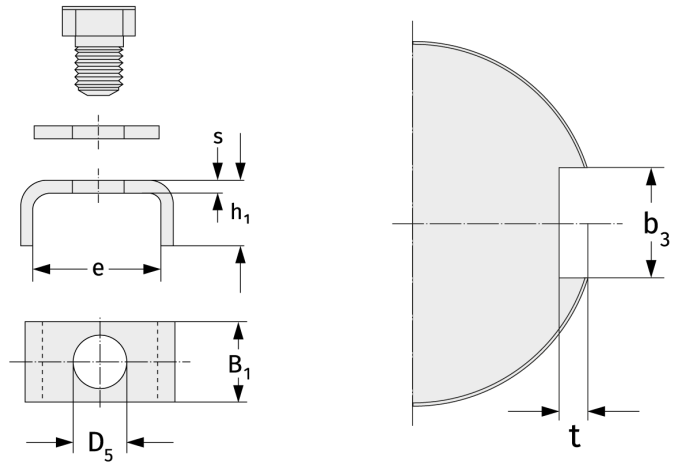

Anschlussmaße

Berechnungsdaten