

N1076M3

Zylinderrollenlager (einreihig, mit Käfig)



Details:

Hauptabmessungen

d [mm]	380	d ₁ [mm]	≈ 443
D [mm]	560	r _{1,2} [mm]	5
B [mm]	82	r _{3,4} [mm]	5
Gewicht [kg]	≈ 66,7	s [mm]	12
E [mm]	515		

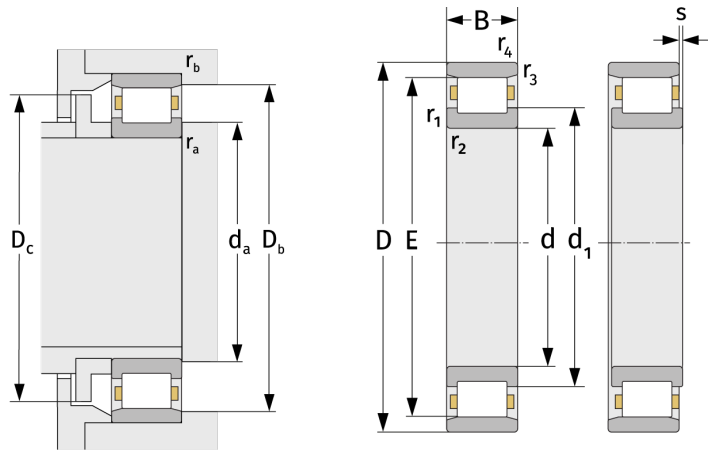

Anschlussmaße		Berechnungsdaten	
d _{a,min} [mm]	398	C [kN]	1200
D _{b,min} [mm]	520	C ₀ [kN]	2040
D _{c,max} [mm]	510	C _u [kN]	178
r _{a,max} [mm]	4	n _{th} [min ⁻¹]	1043
r _{b,max} [mm]	4	n _g [min ⁻¹]	1400