

NJ10/800M3

Zylinderrollenlager (einreihig, mit Käfig)



Details:

Hauptabmessungen

d [mm]	800	d ₁ [mm]	≈ 921
D [mm]	1150	D ₁ [mm]	≈ 1029
B [mm]	155	r _{1,2} [mm]	7,5
Gewicht [kg]	≈ 543	r _{3,4} [mm]	7,5
		s [mm]	17,5
F [mm]	885		

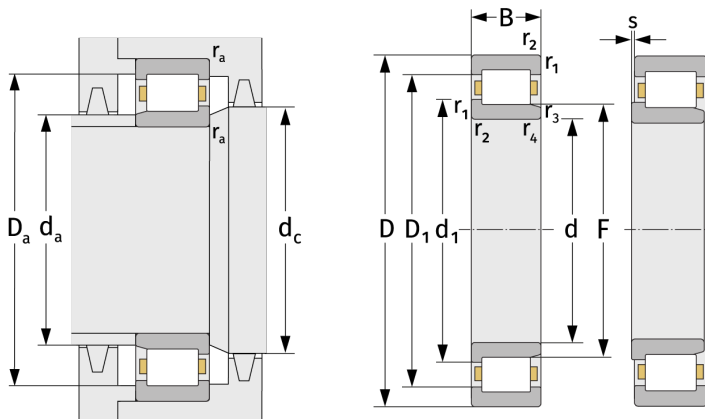

Anschlussmaße		Berechnungsdaten	
d _{a, min} [mm]	828	C [kN]	4970
d _{a, max} [mm]	879	C ₀ [kN]	9950
d _{b, min} [mm]	891	C _u [kN]	704
d _{c, min} [mm]	927	n _{th} [min ⁻¹]	365
D _{a, max} [mm]	1122	n _g [min ⁻¹]	550
r _{a, max} [mm]	6		