

# NJ19/900E.M3

Zylinderrollenlager (einreihig, mit Käfig)



## Details:

### Hauptabmessungen

d [mm]	900	d <sub>1</sub> [mm]	≈ 999
D [mm]	1180	D <sub>1</sub> [mm]	≈ 1089
B [mm]	122	r <sub>1,2</sub> [mm]	6
Gewicht [kg]	≈ 358	r <sub>3,4</sub> [mm]	6
F [mm]	969	s [mm]	8,8

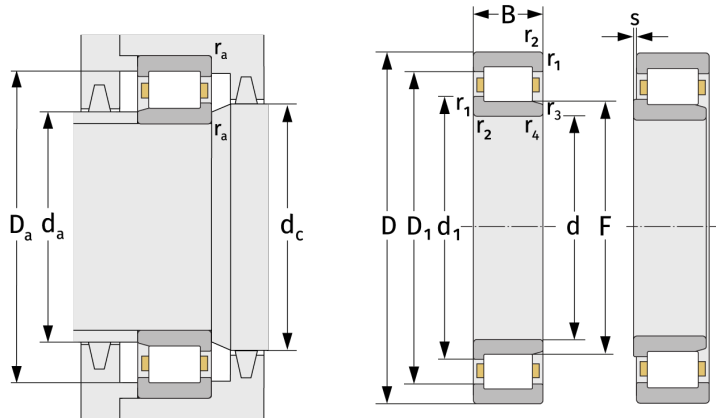

Anschlussmaße		Berechnungsdaten	
d <sub>a, min</sub> [mm]	923	C [kN]	3820
d <sub>a, max</sub> [mm]	964	C <sub>0</sub> [kN]	8300
d <sub>b, min</sub> [mm]	974	C <sub>u</sub> [kN]	576
d <sub>c, min</sub> [mm]	1005	n <sub>th</sub> [min <sup>-1</sup> ]	333
D <sub>a, max</sub> [mm]	1157	n <sub>g</sub> [min <sup>-1</sup> ]	500
r <sub>a, max</sub> [mm]	5		