

NJ2840M3

Zylinderrollenlager (einreihig, mit Käfig)



Details:

Hauptabmessungen

d [mm]	200	d ₁ [mm]	≈ 218,2
D [mm]	250	D ₁ [mm]	≈ 233,8
B [mm]	30	r _{1,2} [mm]	1,5
Gewicht [kg]	≈ 3,46	r _{3,4} [mm]	1,1
		s [mm]	3,8
F [mm]	213		

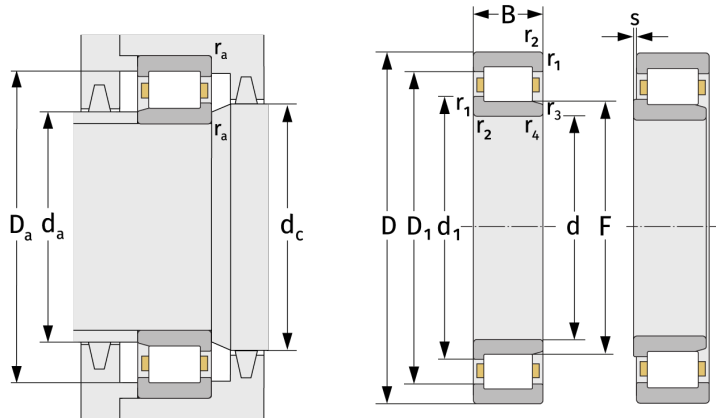

Anschlussmaße		Berechnungsdaten	
d _{a, min} [mm]	207	C [kN]	222
d _{a, max} [mm]	211	C ₀ [kN]	446
d _{b, min} [mm]	215	C _u [kN]	48,1
d _{c, min} [mm]	221	n _{th} [min ⁻¹]	1931
D _{a, max} [mm]	243	n _g [min ⁻¹]	3100
r _{a, max} [mm]	1,5		