

# NN3020S.M

Zylinderrollenlager (zweireihig, mit Käfig)



## Details:

### Hauptabmessungen

d [mm]	100	d <sub>1</sub> [mm]	≈ 119,4
D [mm]	150	d <sub>s</sub> [mm]	3,2
B [mm]	37	n <sub>s</sub> [mm]	6,5
Gewicht [kg]	≈ 2,36	r <sub>1,2</sub> [mm]	1,5
		s [mm]	2,5
E [mm]	137		
E [mm]	137		

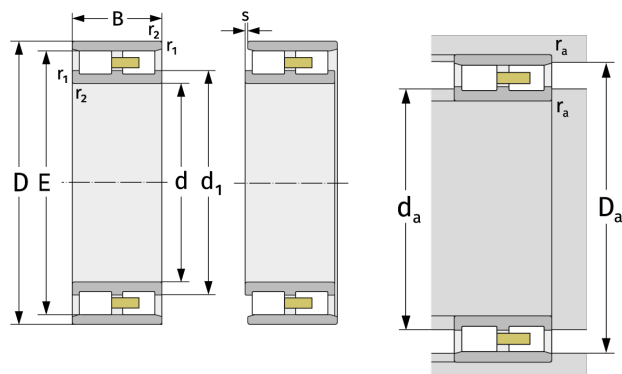

Anschlussmaße		Berechnungsdaten	
D <sub>a,min</sub> [mm]	138	C [kN]	158
d <sub>a,min</sub> [mm]	107	C <sub>0</sub> [kN]	266
D <sub>a,min</sub> [mm]	138	C <sub>u</sub> [kN]	34
D <sub>a,max</sub> [mm]	143	n <sub>G,Fett</sub> [min <sup>-1</sup> ]	5200
r <sub>a,max</sub> [mm]	1,5	n <sub>G,Öl-Luft</sub> [min <sup>-1</sup> ]	6200