

NN3021S.M

Zylinderrollenlager (zweireihig, mit Käfig)



Details:

Hauptabmessungen

d [mm]	105	d ₁ [mm]	≈ 125,2
D [mm]	160	d _s [mm]	3,2
B [mm]	41	n _s [mm]	6,5
Gewicht [kg]	≈ 3,01	r _{1,2} [mm]	2
		s [mm]	2,6
E [mm]	146		
E [mm]	146		

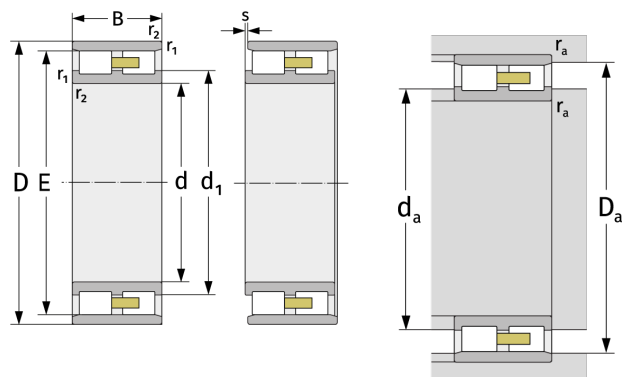

Anschlussmaße		Berechnungsdaten	
D _{a,min} [mm]	147	C [kN]	196
d _{a,min} [mm]	114	C ₀ [kN]	317
D _{a,min} [mm]	147	C _u [kN]	39,8
D _{a,max} [mm]	151	n _{G,Fett} [min ⁻¹]	5000
r _{a,max} [mm]	2	n _{G,Öl-Luft} [min ⁻¹]	5800