

NN3060S.M

Zylinderrollenlager (zweireihig, mit Käfig)



Details:

Hauptabmessungen

d [mm]	300	d ₁ [mm]	≈ 360,4
D [mm]	460	d _s [mm]	9,5
B [mm]	118	n _s [mm]	17,7
Gewicht [kg]	≈ 72	r _{1,2} [mm]	4
E [mm]	418	s [mm]	7,4

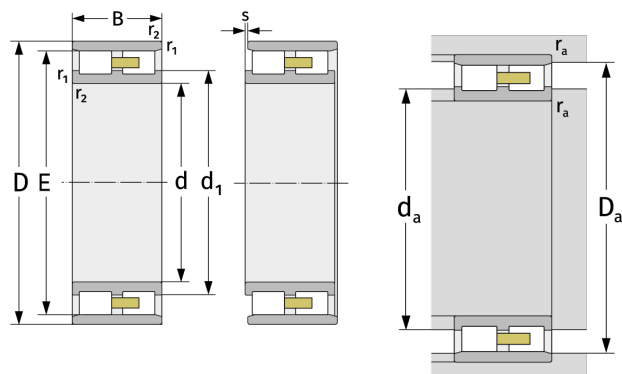

Anschlussmaße		Berechnungsdaten	
d _{a, min} [mm]	315	C [kN]	1320
D _{a, min} [mm]	421	C ₀ [kN]	2510
D _{a, max} [mm]	445	C _u [kN]	234
r _{a, max} [mm]	3	n _{G, Fett} [min ⁻¹]	1600
		n _{G, Öl-Luft} [min ⁻¹]	1900