

NNCF4896V

Zylinderrollenlager (zweireihig, vollrollig)



Details:

Hauptabmessungen

d [mm]	480	d_s [mm]	8
D [mm]	600	n_s [mm]	15
B [mm]	118	$r_{1,2}$ [mm]	3
Gewicht [kg]	≈ 78,9	$r_{3,4}$ [mm]	3
		s [mm]	7
d_1 [mm]	≈ 527,3		
D_1 [mm]	≈ 557,3		

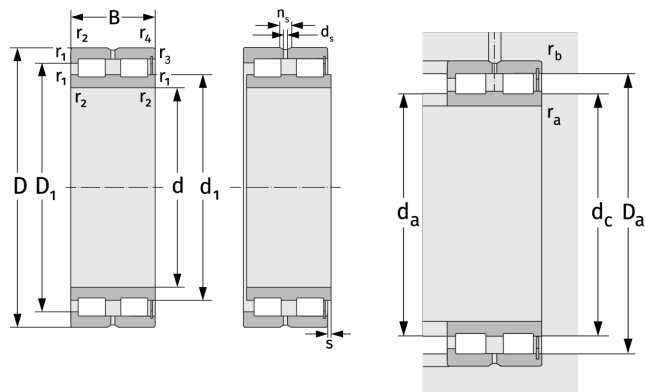

Anschlussmaße		Berechnungsdaten	
$d_{a, \min}$ [mm]	492,4	C [kN]	1770
$d_{c, \text{empf}}$ [mm]	522	C_0 [kN]	5500
$D_{a, \max}$ [mm]	587,6	C_u [kN]	462
$r_{a, \max}$ [mm]	2,5	n_{th} [min^{-1}]	269
$r_{b, \max}$ [mm]	2,5	n_g [min^{-1}]	530