

NNCF4922V

Zylinderrollenlager (zweireihig, vollrollig)



Details:

Hauptabmessungen

d [mm]	110	d_s [mm]	3,2
D [mm]	150	n_s [mm]	6,5
B [mm]	40	$r_{1,2}$ [mm]	1,1
Gewicht [kg]	≈ 2,13	$r_{3,4}$ [mm]	1,1
d_1 [mm]	≈ 123,8	s [mm]	2
D_1 [mm]	≈ 134,6		

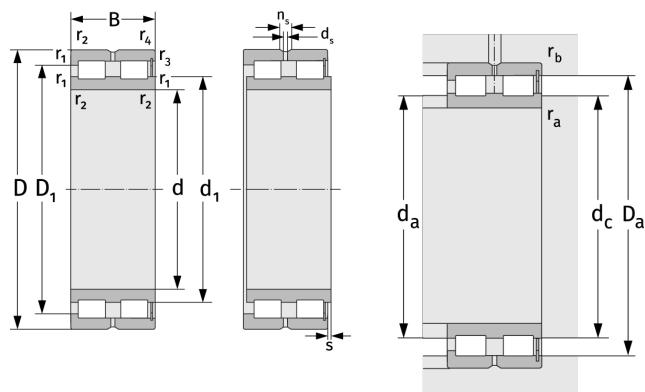

Anschlussmaße		Berechnungsdaten	
$d_{a, \min}$ [mm]	116	C [kN]	203
$d_{c, \text{empf}}$ [mm]	123	C_0 [kN]	432
$D_{a, \max}$ [mm]	144	C_u [kN]	54,7
$r_{a, \max}$ [mm]	1	n_{th} [min^{-1}]	1544
$r_{b, \max}$ [mm]	1	n_g [min^{-1}]	2600