

NNCF4980V

Zylinderrollenlager (zweireihig, vollrollig)



Details:

Hauptabmessungen

d [mm]	400	d_s [mm]	4,8
D [mm]	540	n_s [mm]	9,5
B [mm]	140	$r_{1,2}$ [mm]	4
Gewicht [kg]	≈ 95,1	$r_{3,4}$ [mm]	4
d_1 [mm]	≈ 450,54	s [mm]	7
D_1 [mm]	≈ 488,94		

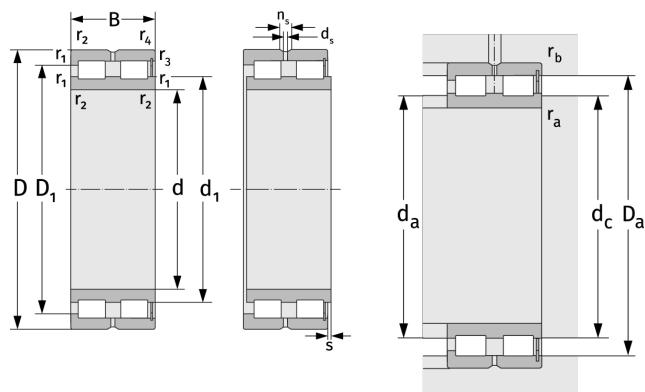

Anschlussmaße		Berechnungsdaten	
$d_{a, \min}$ [mm]	414,6	C [kN]	2290
$d_{c, \text{empf}}$ [mm]	446	C_0 [kN]	6050
$D_{a, \max}$ [mm]	525,4	C_u [kN]	530
$r_{a, \max}$ [mm]	3	n_{th} [min ⁻¹]	295
$r_{b, \max}$ [mm]	3	n_g [min ⁻¹]	630