

NNCF5076V

Zylinderrollenlager (zweireihig, vollrollig)



Details:

Hauptabmessungen

d [mm]	380	d_s [mm]	6,3
D [mm]	560	n_s [mm]	12,2
B [mm]	243	$r_{1,2}$ [mm]	5
Gewicht [kg]	≈ 194	$r_{3,4}$ [mm]	5
		s [mm]	11
d_1 [mm]	≈ 431,7		
D_1 [mm]	≈ 498,9		

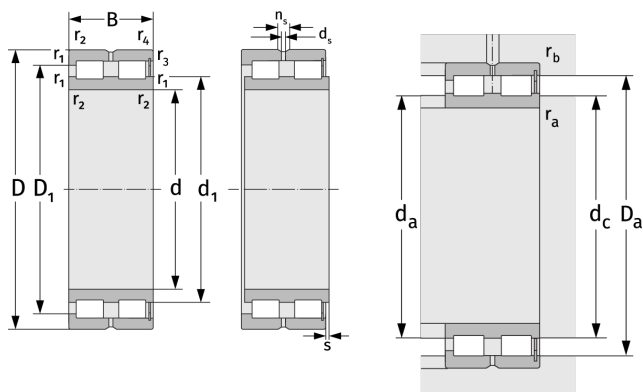

Anschlussmaße		Berechnungsdaten	
$d_{a, \min}$ [mm]	398	C [kN]	4370
$d_{c, \text{empf}}$ [mm]	427	C_0 [kN]	9250
$D_{a, \max}$ [mm]	542	C_u [kN]	812
$r_{a, \max}$ [mm]	4	n_{th} [min^{-1}]	294
$r_{b, \max}$ [mm]	4	n_g [min^{-1}]	630