

NNU40/500S.M

Zylinderrollenlager (zweireihig, mit Käfig)



Details:

Hauptabmessungen

d [mm]	500	D_1 [mm]	$\approx 647,6$
D [mm]	720	d_s [mm]	9,5
B [mm]	218	n_s [mm]	17,7
Gewicht [kg]	≈ 297	$r_{1,2}$ [mm]	6
		s [mm]	7,7
F [mm]	558		

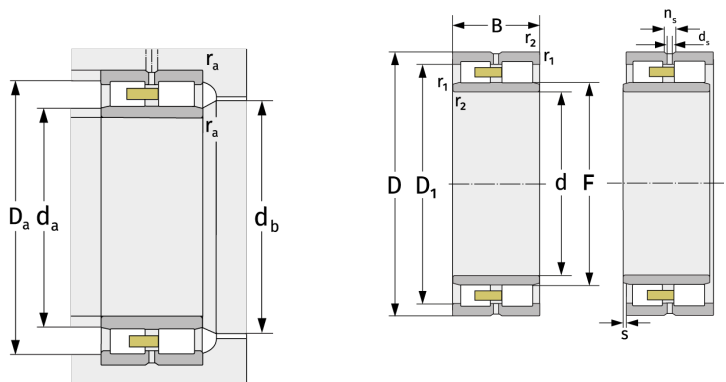

Anschlussmaße		Berechnungsdaten	
$d_{a, \min}$ [mm]	523	C [kN]	4340
$d_{a, \max}$ [mm]	554	C_0 [kN]	10100
$d_{b, \min}$ [mm]	562	C_u [kN]	820
$D_{a, \max}$ [mm]	697	$n_{G, \text{Fett}}$ [min^{-1}]	910
$r_{a, \max}$ [mm]	5	$n_{G, \text{Öl-Luft}}$ [min^{-1}]	1100