

NNU40/600S.M

Zylinderrollenlager (zweireihig, mit Käfig)



Details:

Hauptabmessungen

d [mm]	600	D_1 [mm]	≈ 776
D [mm]	870	d_s [mm]	12,5
B [mm]	272	n_s [mm]	23,5
Gewicht [kg]	≈ 543	$r_{1,2}$ [mm]	6
		s [mm]	9,3
F [mm]	664		

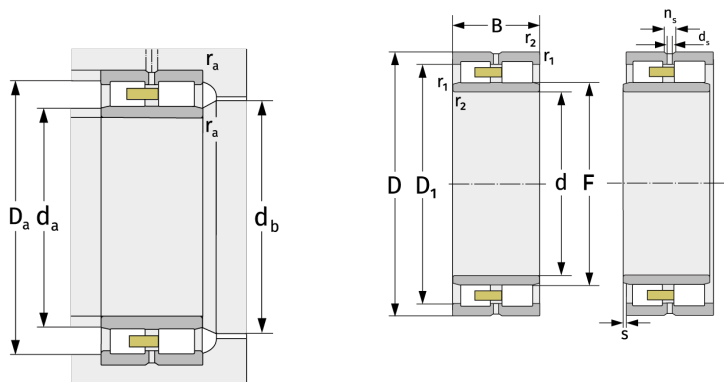

Anschlussmaße		Berechnungsdaten	
$d_{a, \min}$ [mm]	623	C [kN]	6250
$d_{a, \max}$ [mm]	658	C_0 [kN]	14500
$d_{b, \min}$ [mm]	669	C_u [kN]	1120
$D_{a, \max}$ [mm]	847	$n_{G, \text{Fett}}$ [min^{-1}]	730
$r_{a, \max}$ [mm]	5	$n_{G, \text{Öl-Luft}}$ [min^{-1}]	850