

NNU40/750S.M

Zylinderrollenlager (zweireihig, mit Käfig)



Details:

Hauptabmessungen

d [mm]	750	D_1 [mm]	≈ 974
D [mm]	1090	d_s [mm]	12,5
B [mm]	335	n_s [mm]	23,5
Gewicht [kg]	≈ 1061	$r_{1,2}$ [mm]	7,5
		s [mm]	13,5
F [mm]	830		

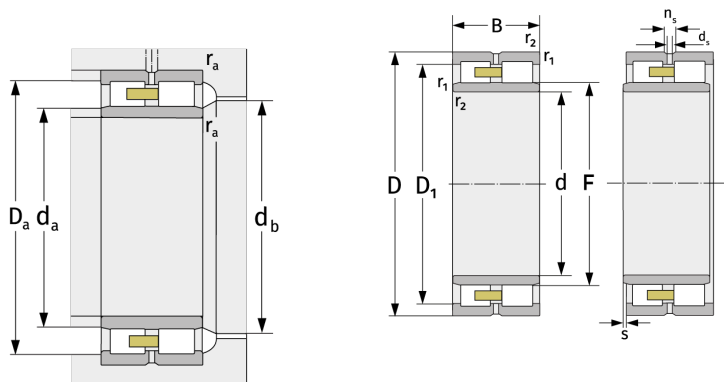

Anschlussmaße		Berechnungsdaten	
$d_{a, \min}$ [mm]	778	C [kN]	10100
$d_{a, \max}$ [mm]	823	C_0 [kN]	24100
$d_{b, \min}$ [mm]	835	C_u [kN]	1750
$D_{a, \max}$ [mm]	1062	$n_{G, \text{Fett}}$ [min^{-1}]	540
$r_{a, \max}$ [mm]	6	$n_{G, \text{Öl-Luft}}$ [min^{-1}]	630