

NNU41/560S.M

Zylinderrollenlager (zweireihig, mit Käfig)



Details:

Hauptabmessungen

d [mm]	560	D_1 [mm]	≈ 805
D [mm]	920	d_s [mm]	12,5
B [mm]	355	n_s [mm]	23,5
Gewicht [kg]	≈ 945	$r_{1,2}$ [mm]	7,5
		s [mm]	16,6
F [mm]	653		

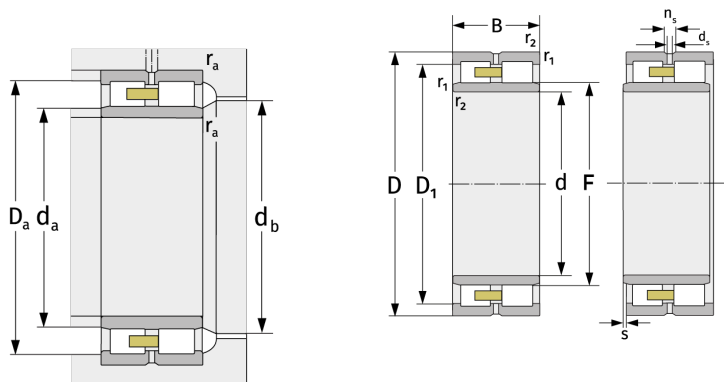

Anschlussmaße		Berechnungsdaten	
$d_{a, \min}$ [mm]	592	C [kN]	8850
$d_{a, \max}$ [mm]	648	C_0 [kN]	18300
$d_{b, \min}$ [mm]	657	C_u [kN]	1410
$D_{a, \max}$ [mm]	888	$n_{G, \text{Fett}}$ [min^{-1}]	710
$r_{a, \max}$ [mm]	6	$n_{G, \text{Öl-Luft}}$ [min^{-1}]	830